

T1 rem 2: hoorwoorden met een korte klank sorteren

de korte klanken

de **a** van rat

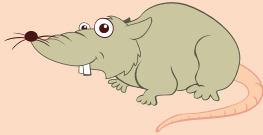

de **e** van et



de **i** van in



de **o** van op



de **u** van put



1 niet lang, maar kort

 verbind de letters onder de ratkaart met elkaar.

 schrijf de woorden op.

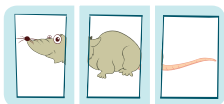

p — a — s

pas

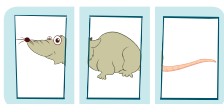

t — e — l

tel

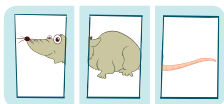

z — i — t

zit

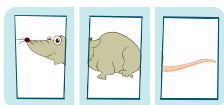

v — o — l

vol

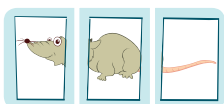

z — u — s

zus

2 mijn buik zit vol



■ kleur de buik van elk woord **blauw**.



■ schrijf de woorden in de goede rij.

v a n

t i k

l u s

t o p

r e n

l e s

v o l

r a p

z i n

v u l

a van rap

o top vol

e ren les

u lus vul

i tik zin

3 ik doe het zelf wel



■ zoek bij elke klank twee woorden.



■ schrijf de woorden op.

a eigen antwoord

o

e

u

i

■ een foutje mag. schrijf het hier eenmaal goed.
vertel me hoe je het doet!

hoe deed ik de taak?



ik denk



juf/meester vindt



naam: _____

datum: _____

klas: _____

klasnummer: _____





tip! voor ouders: lees de opdracht voor.

- 1  overtrek 1 gebogen lijn met **groen**.
- overtrek 1 rechte lijn met **rood**.
- overtrek 1 gebroken lijn met **blauw**.

-  kleur 1 vierkant **geel**.
- kleur 1 cirkel **roze**.
- kleur 1 driehoek **bruin**.

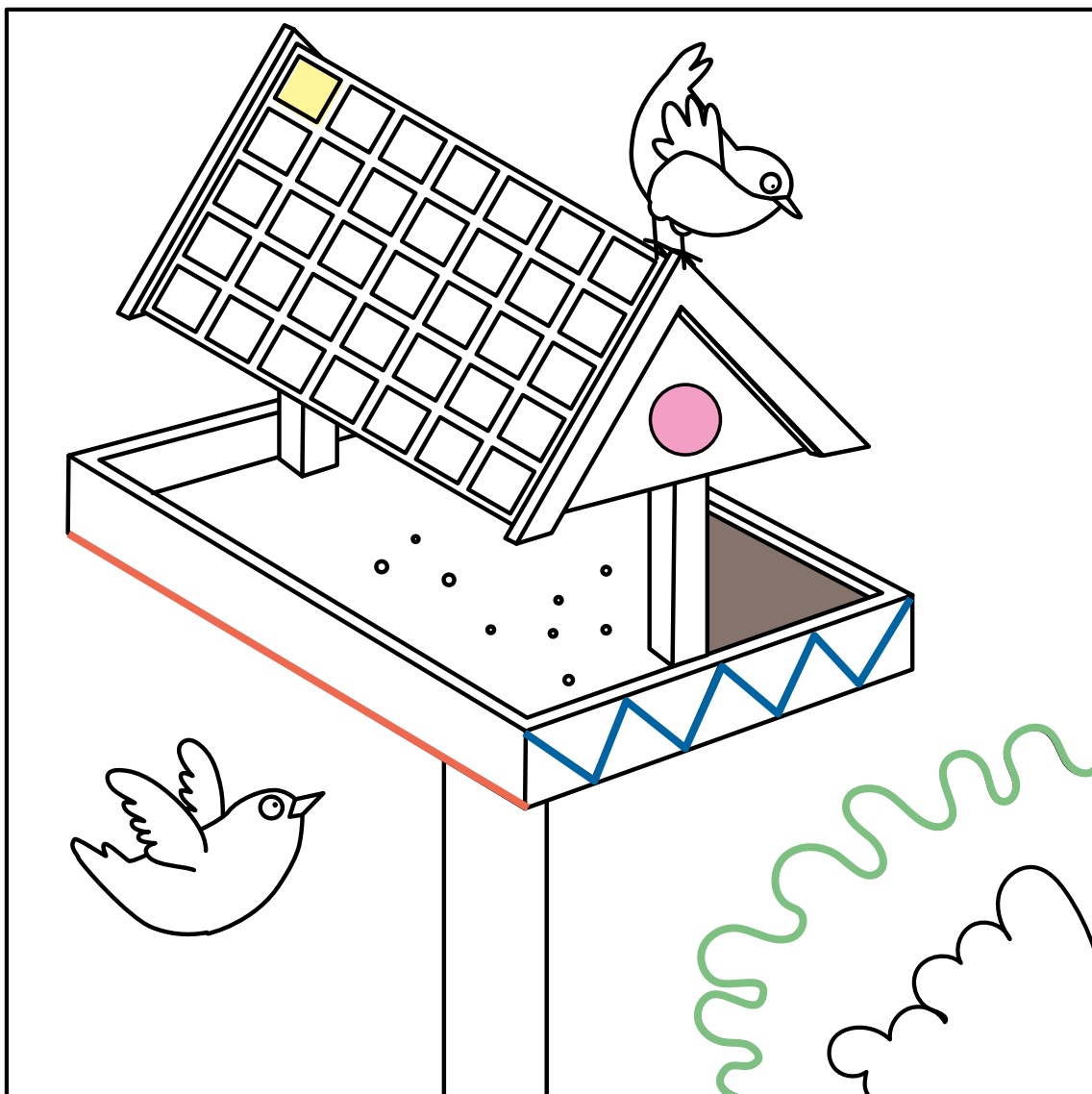
meerdere oplossingen mogelijk



2  teken de figuren na.

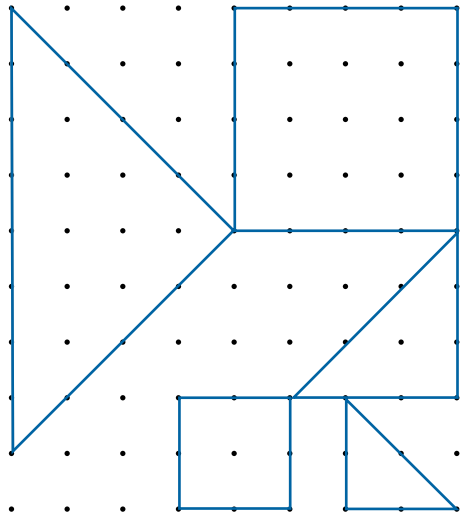
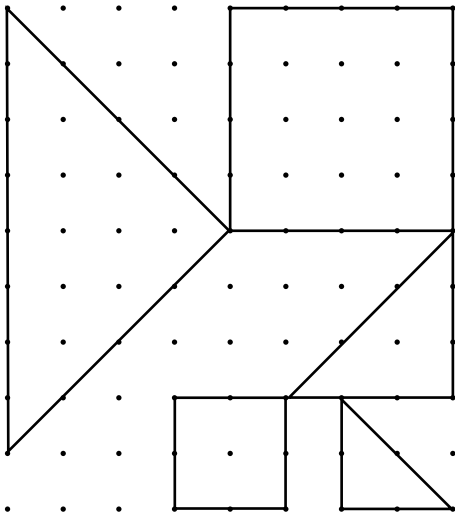
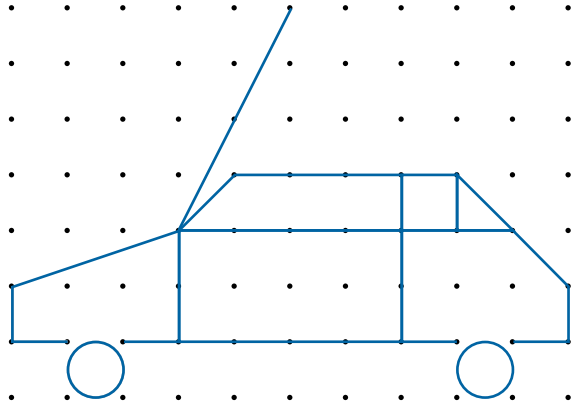
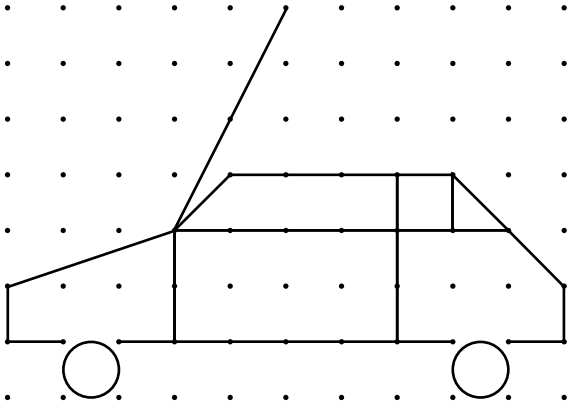

ik vond de taak



ik maakte de taak alleen.



ik kreeg hulp.



opmerking ouders: _____